



Test Procedure for LC709204F Evaluation board

1 Evaluation Kit

1.1 How to select Evaluation board

- Select a suitable Evaluation board according to target device and your battery.

Evaluation board	Target device	Battery type	Related documents
LC709204FXE-01-GEVB	LC709204FXE-01TBG	01, 04, 05, 06, 07	<i>LC709204FXE-01-GEVB_SCHEMATIC.pdf</i> <i>LC709204FXE-01-GEVB_GERBER.zip</i> <i>LC709204FXE-01-GEVB_BOM.pdf</i>

Battery profile vs registers

IC Type	Battery Type	Nominal / Rated Voltage	Charging Voltage	Number of The Parameter (0x1A)	Change of The Parameter (0x12)
LC709204FXE-01TBG	01	3.7 V	4.2 V	0x1001	0x00
	04	UR18650ZY (Panasonic)			0x01
	05	ICR18650-26H (SAMSUNG)			0x02
	06	3.8 V	4.35 V		0x03
	07	3.85V	4.4V		0x04



1.2 Evaluation board

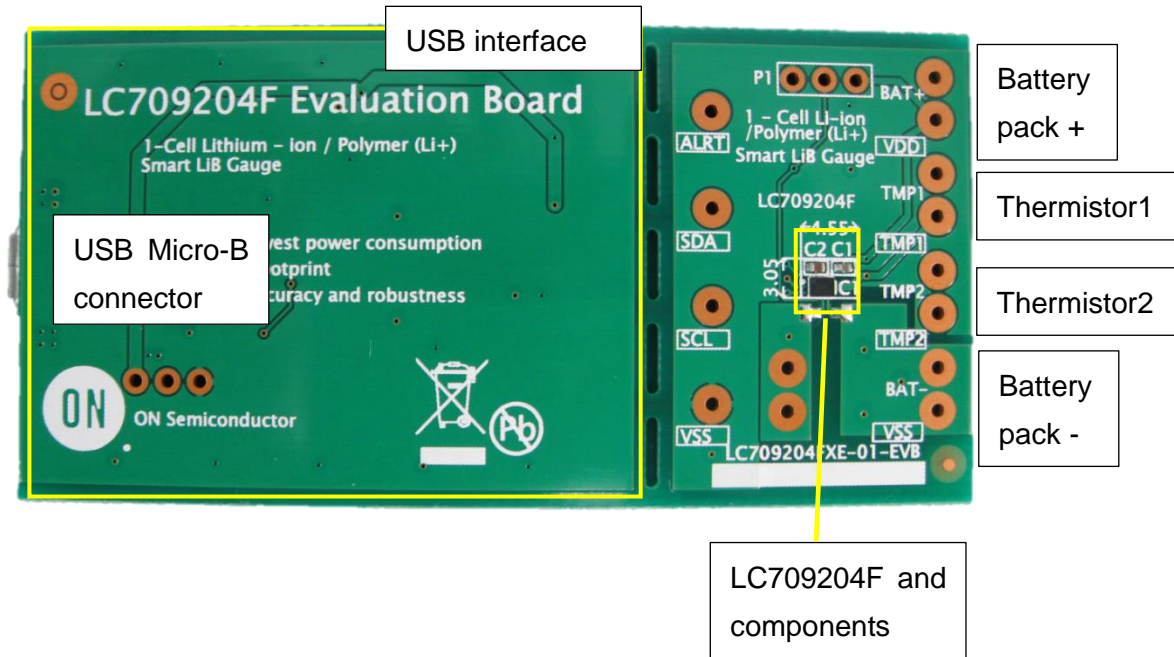

1.3 Windows application

- FGICTool_Verxxx.exe. The software can be downloaded at ON Semiconductor Web site. ([Software](#))

1.4 Evaluation board Block diagram

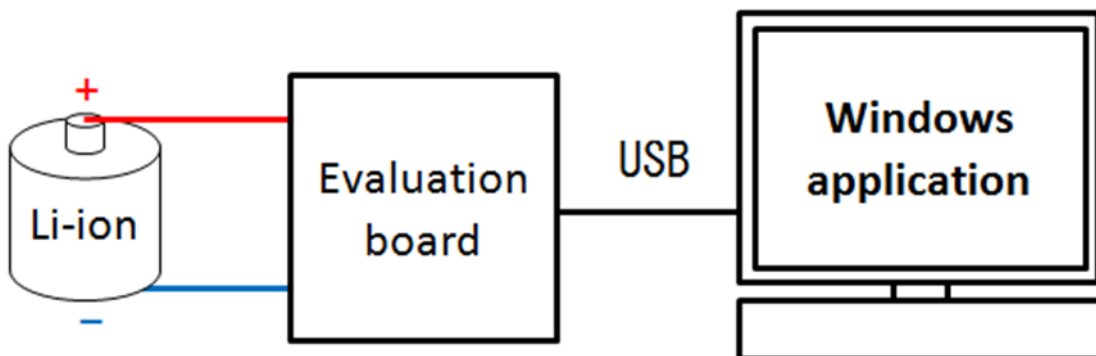



2 How to connect Evaluation board

2.1 Connection of Evaluation board and Battery

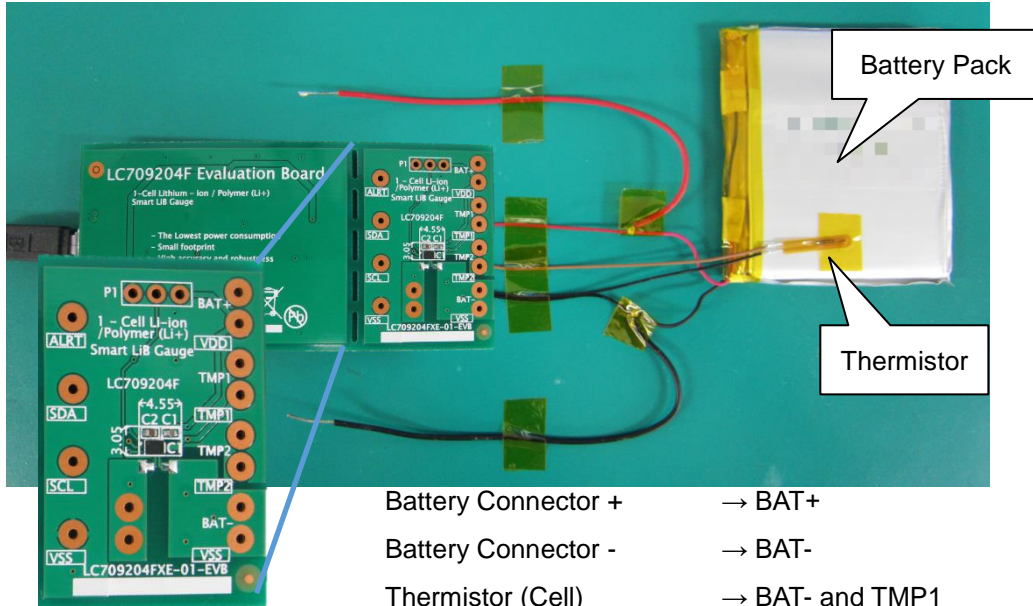

- Battery Connector + → BAT+
 - Battery Connector - → BAT-
 - Thermistor (Cell) → BAT- and TMP1
 - Thermistor (Ambient) → BAT- and TMP2
- Note: 10 kΩ NTC thermistor is required.

Ex. SEMITEC 103JT-025

2.2 Connection of PC and EVA board

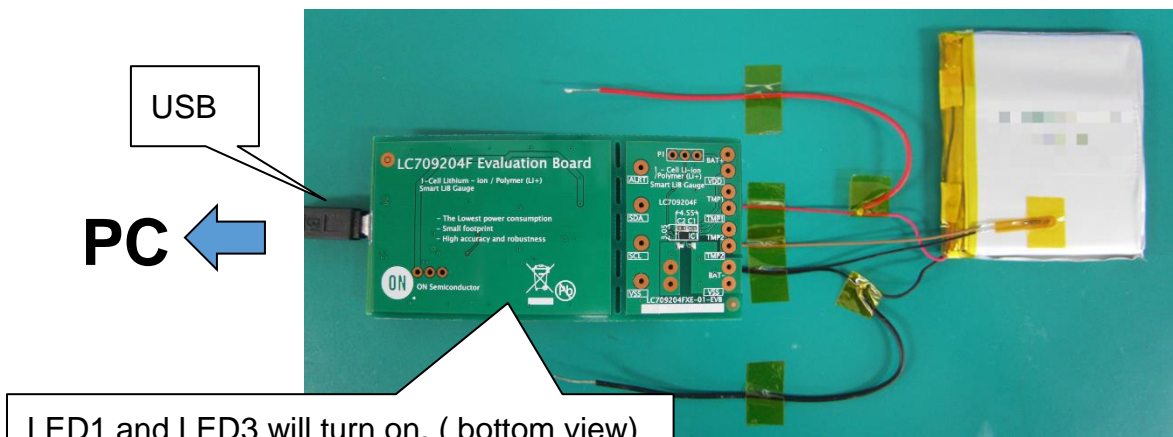

LED1 and LED3 will turn on. (bottom view)

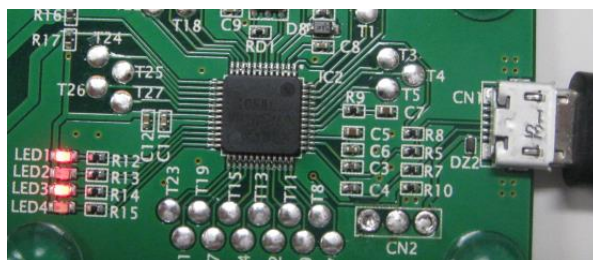



3 How to start application

3.1 Start application

- Click “FGICTool_verxxx.exe”

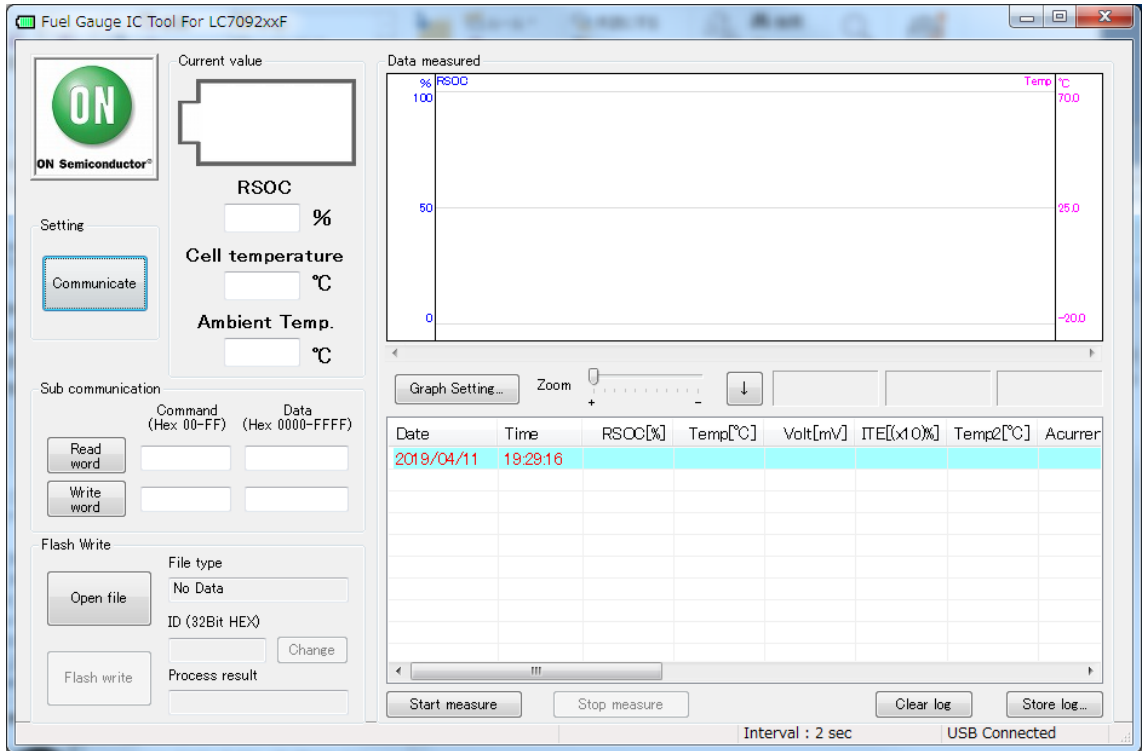

3.2 Select communication type

- Click “Communicate” and select I2C.

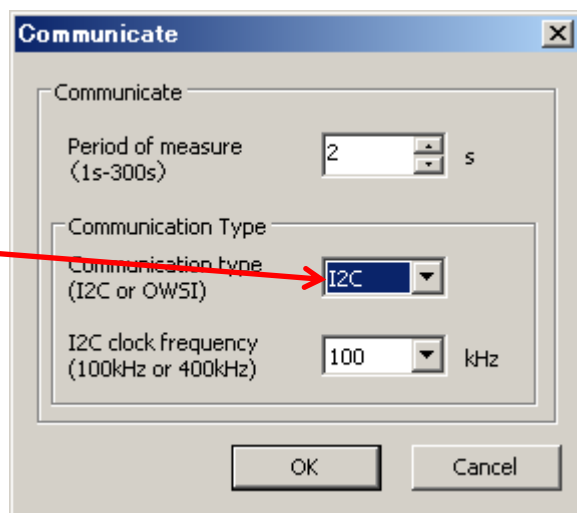
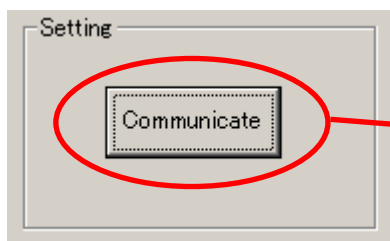



- Select time interval of log and I2C clock frequency.

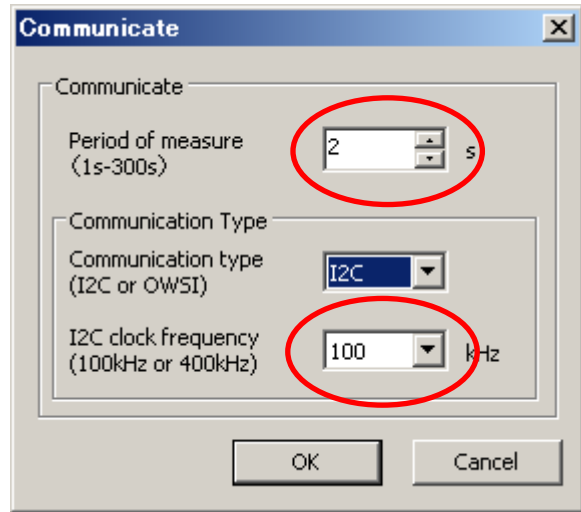

4 Register setting

4.1 Set Operational mode

- Setting registers
 - Input 「15」 in the Command field.
 - Input 「0001」 in the Data field.



0x15	IC Power Mode	R/W	0x0001: Operational mode 0x0002: Sleep mode	Selects Power mode	0x0002
------	---------------	-----	--	--------------------	--------

- Click "Write word".





4.2 Set APA

Set APA parameter that is suitable for your battery. Refer datasheet about typical APA. The applied APA value is selected by the design capacity of your battery and Battery type. Select Maximum APA when your design capacity exceeds the listed capacity.

- Setting registers

- Input 「0B」 in the Command field.

- Input 「0000 to FFFF (a value suitable for your battery)」 in the Data field.

Note: For example the set value in APA register is 0x0D0D for 0x0D APA value.

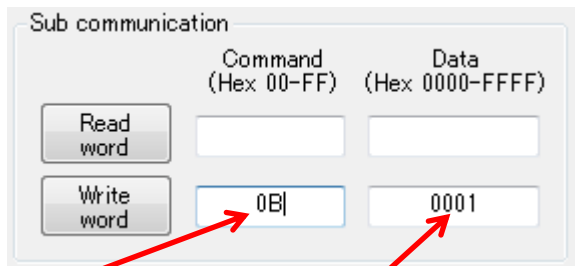

0x0B	APA ₊ (Adjustment Pack Application)	R/W	0x0000 to 0xFFFF	Sets Adjustment parameter...	-
------	---	-----	------------------	------------------------------	---

- Click “Write word”.

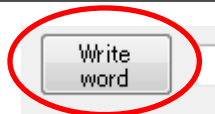

Typical APA

Design Capacity	APA[15:8] / APA[7:0]		
	Type-01	Type-06	Type-07
50 mAh	0x13	0x0C	0x03
100 mAh	0x15	0x0E	0x05
200 mAh	0x18	0x11	0x07
500 mAh	0x21	0x17	0x0D
1000 mAh	0x2D	0x1E	0x13
2000 mAh	0x3A	0x28	0x19
3000 mAh	0x3F	0x30	0x1C
4000 mAh	0x42	0x34	-
5000 mAh	0x44	0x36	-
6000 mAh	0x45	0x37	-

Design Capacity	APA[15:8] / APA[7:0]	
	Type-04	Type-05
2600 mAh	0x10	0x06



4.3 Select battery profile

Select and set a profile that is suitable for your battery from the datasheet.

- Setting registers

- Input 「12」 in the Command field.

- Input 「0000 or 0001」 in the Data field.

Sub communication

	Command (Hex 00-FF)	Data (Hex 0000-FFFF)
Read word	<input type="text"/>	<input type="text"/>
Write word	<input type="text" value="12"/>	<input type="text" value="0001"/>

0x12	Change Of The Parameter	R/W	0x0000 to 0x0004	Selects a battery profile.	0x0000
------	-------------------------	-----	------------------	----------------------------	--------

- Click "Write word".



IC Type	Battery Type	Nominal / Rated Voltage	Charging Voltage	Number of The Parameter (0x1A)	Change of The Parameter (0x12)
LC709204FXE-01TBG	01	3.7 V	4.2 V	0x1001	0x00
	04	UR18650ZY (Panasonic)			0x01
	05	ICR18650-26H (SAMSUNG)			0x02
	06	3.8 V	4.35 V		0x03
	07	3.85V	4.4V		0x04



4.4 Initialize RSOC

Execute RSOC initialization.

- Setting registers
 - Input 「07」 in the Command field.
 - Input 「AA55」 in the Data field.

0x07	Initial RSOC	W	0xAA55: Initialize RSOC	Initialize RSOC with current voltage when 0xAA55 is set
------	--------------	---	-------------------------	---

- Click “Write word”.



Note: The accuracy of the Initialization requires the OCV reading to be taken with minimal load or charge, under 0.025C, on the battery. (i.e. less than 75mA for 3000mAh design capacity battery.)

4.5 Set Thermistor mode

Select Thermistor mode.

- Setting registers
 - Input 「16」 in the Command field.
 - Input 「0001」 in the Data field.

0x16	Status Bit	R/W	0x0000 to 0x0003	BIT0: Controls TSENSE1 thermistor, BIT1: Controls TSENSE2 thermistor	0x0000
------	------------	-----	------------------	--	--------

- Click “Write word”.

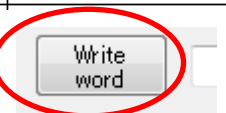

Note: This setting is not required if this LSI receives Cell temperature from Master device via I2C.



4.6 Set Thermistor B

Set a value that is suitable for your thermistor for TSENSE1, TSENSE2. Refer to the datasheet of the thermistor for the B constant.

- Setting registers
 - Input 「06」 in the Command field.(「0E」 TSENSE2)
 - Input 「B constant」 in the Data field.

Address	Name	Access	Range	Unit	Description	Default Value
0x06	TSENSE1 Thermistor B.	R/W	0x0000 to 0xFFFF	K	Sets B-constant of the TSENSE1 thermistor.	0x0D34 (3380K)
0x0E	TSENSE2 Thermistor B.	R/W	0x0000 to 0xFFFF	K	Sets B-constant of the TSENSE2 thermistor.	0x0D34 (3380K)

- Click "Write word".



5 Starting evaluation

5.1 Measurements and Logging

- Click "Start measure".

Date	Time	RSOC[%]	Temp[°C]	Volt[mV]	ITEI[x10%	Temp2[°C]	Acur
2019/04/11	19:35:38	90	25.4	4249	0	0.0	
2019/04/11	19:35:40	90	25.4	4248	0	0.0	
2019/04/11	19:35:42	90	25.3	4248	0	0.0	
2019/04/11	19:35:44	90	25.4	4246	0	0.0	
2019/04/11	19:35:46	90	25.4	4247	0	0.0	
2019/04/11	19:35:48	90	25.4	4245	0	0.0	
2019/04/11	19:35:50	90	25.5	4245	0	0.0	
2019/04/11	19:35:52	90	25.4	4245	0	0.0	
2019/04/11	19:35:54	90	25.4	4244	0	0.0	

- Application starts measurements and logging.



5.2 Start charging/discharging

- Connect charger/load to your battery.

Charge or Discharge Example

- Battery charger
- Load equipment
- Various device

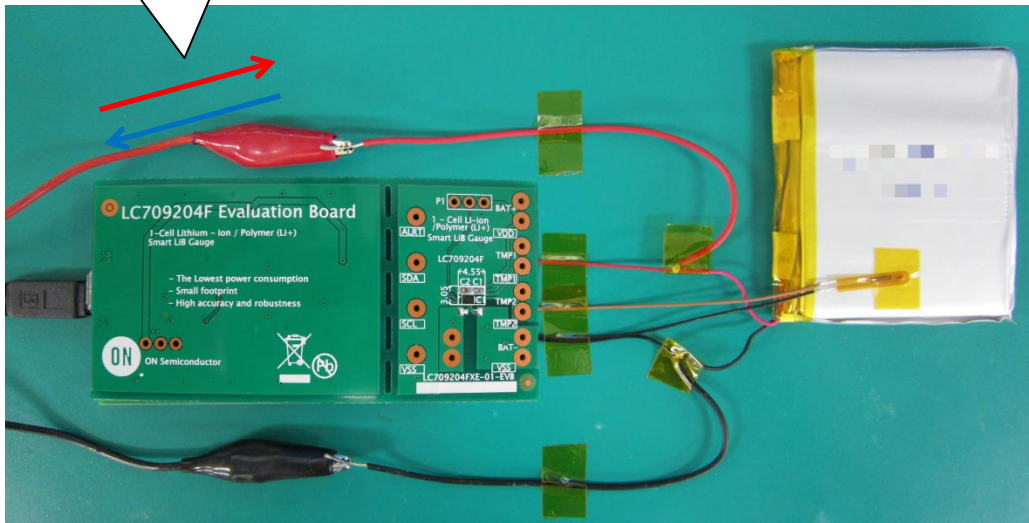

5.3 Logging while Charging/Discharging

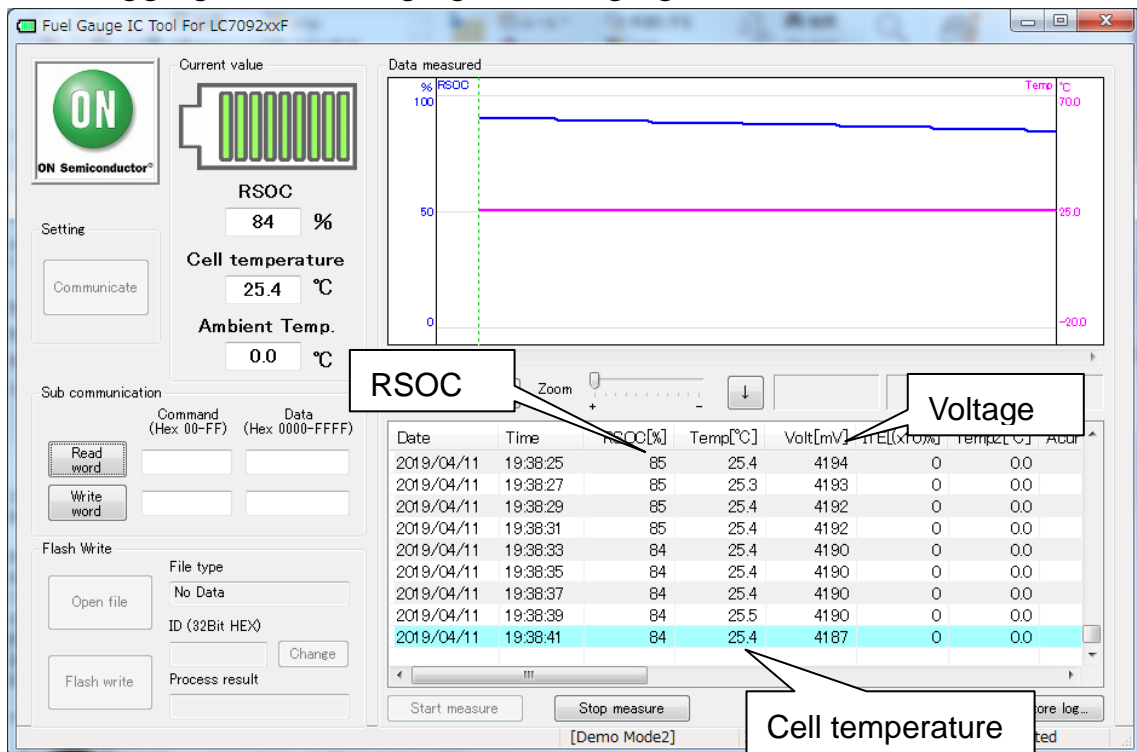



Display in GUI	Command Code	Register Name	Comment
RSOC	0x0D	RSOC	
Temp	0x08	Cell Temperature	
Volt	0x09	Cell Voltage	
ITE	0x0F	ITE	
Temp2	0x30	Ambient Temperature	
Acurrent	0x34	Average Cell Current	Acurrent=0 for LC709204FXE Cell Current = Acurrent * Sense resistance
MaxCellVolt	0x2A	Maximum Cell Voltage	
MinCellVolt	0x2B	Minimum Cell Voltage	
MinDcurrent	0x2F	Minimum Cell Current	MinDcurrent=0 for LC709204FXE Cell Current = MinDcurrent * Sense resistance



5.4 End the measurements

- To end, click “Stop measure”.

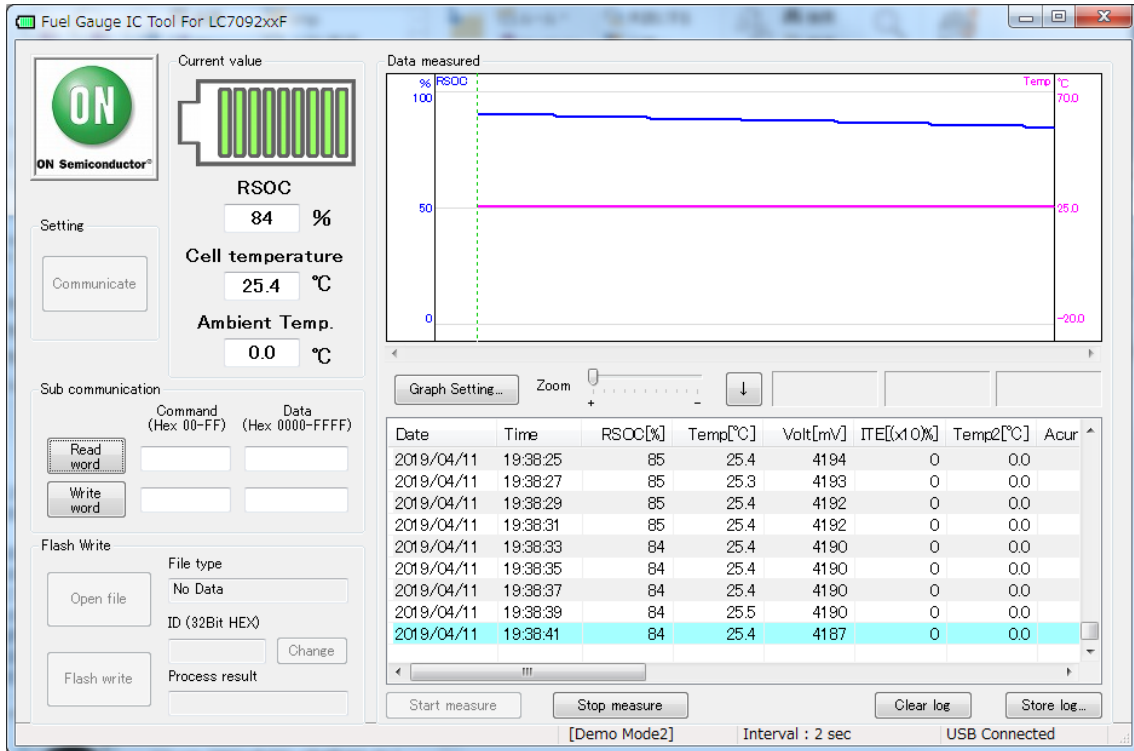

5.5 Store log

This application can save all measurement log as a text file.

- To save a log, click “Store log”.

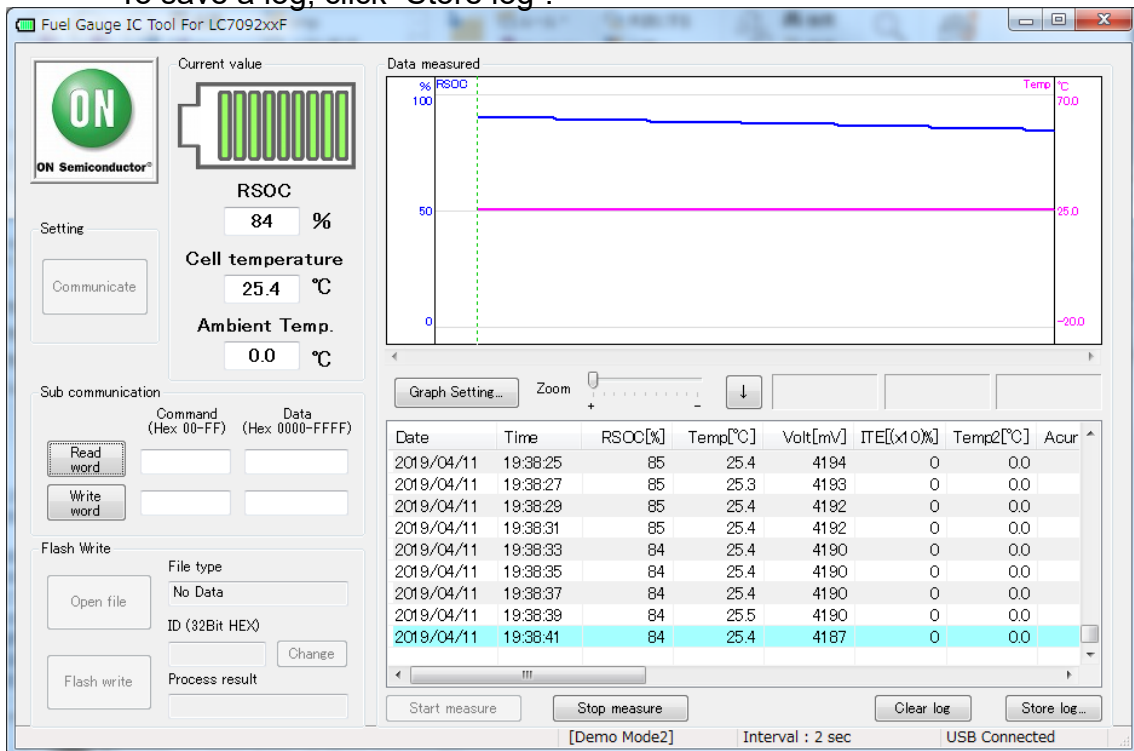



5.6 Convert log file format

The output text file can be converted to Excel format csv. The conversion to csv facilitates the analysis of data.

- Change the file format from .txt to .csv. Example) test.txt → test.csv.

2017/05/08 20:04:25, 99, 19.4, 4091	11	2017/5/8 20:04	99	19.4	4091
2017/05/08 20:04:27, 99, 19.4, 4087	12	2017/5/8 20:04	99	19.4	4087
2017/05/08 20:04:29, 99, 19.4, 4087	13	2017/5/8 20:04	99	19.4	4087
2017/05/08 20:04:31, 99, 19.4, 4087	14	2017/5/8 20:04	99	19.4	4087
2017/05/08 20:04:33, 99, 19.4, 4087	15	2017/5/8 20:04	99	19.4	4087
2017/05/08 20:04:35, 99, 19.4, 4084	16	2017/5/8 20:04	99	19.4	4084
2017/05/08 20:04:37, 99, 19.4, 4084	17	2017/5/8 20:04	99	19.4	4084
2017/05/08 20:04:39, 99, 19.4, 4084	18	2017/5/8 20:04	99	19.4	4084
2017/05/08 20:04:41, 99, 19.4, 4080	19	2017/5/8 20:04	99	19.4	4080
2017/05/08 20:04:43, 99, 19.4, 4080	20	2017/5/8 20:04	99	19.4	4080
2017/05/08 20:04:45, 99, 19.4, 4080	21	2017/5/8 20:04	99	19.4	4080
2017/05/08 20:04:47, 99, 19.4, 4080	22	2017/5/8 20:04	99	19.4	4080
2017/05/08 20:04:49, 99, 19.4, 4077	23	2017/5/8 20:04	99	19.4	4077
2017/05/08 20:04:51, 99, 19.4, 4077	24	2017/5/8 20:04	99	19.4	4077
2017/05/08 20:04:53, 99, 19.4, 4077	25	2017/5/8 20:04	99	19.4	4077
2017/05/08 20:04:55, 99, 19.4, 4077	26	2017/5/8 20:04	99	19.4	4077
2017/05/08 20:04:57, 99, 19.4, 4077	27	2017/5/8 20:04	99	19.4	4077
2017/05/08 20:04:59, 99, 19.4, 4077	28	2017/5/8 20:04	99	19.4	4077



5.7 Graph

5.7.1 .csv file

- Graph the .csv file.

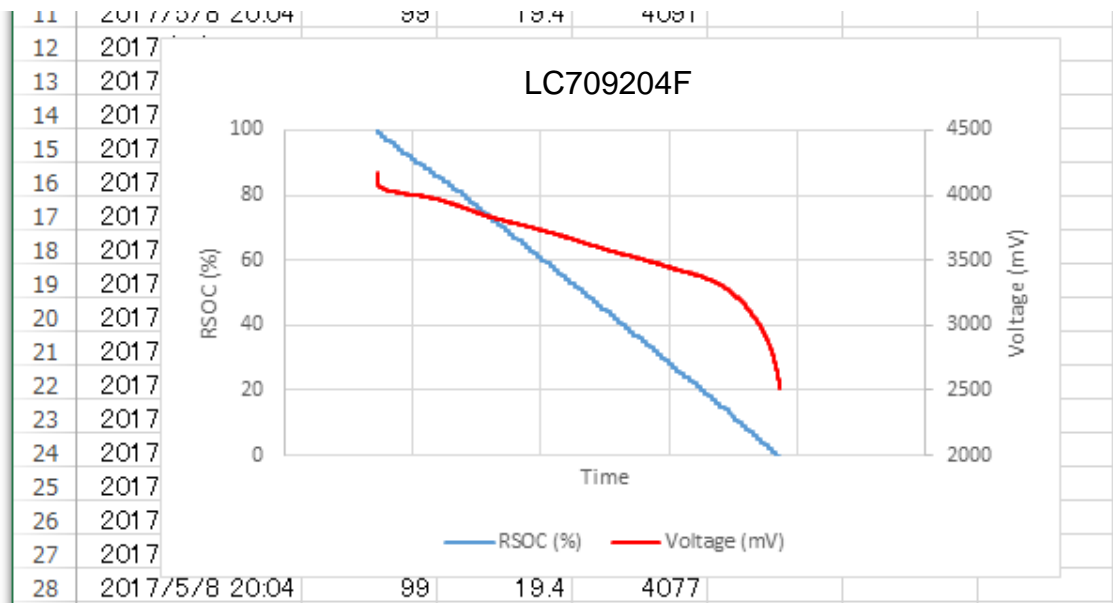

This graph shows association between time and cell voltage and RSOC in constant current discharging.



5.7.2 FGI Graph

- (1) Click “Graph Setting”
- (2) Select “Graph 1 and 2”
- (3) Change the value of range for each graph
- (4) Apply

Cursor

Display range

Jump to Cursor

Graph Setting

Parameter	Min	Max
RSOC	0 %	100 %
Temp	-20.0 °C	70.0 °C
volt	0 mV	5000 mV
ITE	0 x10%	1000 x10%
Temp2	-20.0 °C	70.0 °C
acurrent	-32768 uV	32767 uV
MaxCellVolt	2500 mV	5000 mV
MinCellVolt	2500 mV	5000 mV
MinDcurrent	-32768 uV	32767 uV
None		

Cancel OK Apply

6 FAQ's

Q. How do I know what battery profile to use?

A. Battery characteristics are listed on Table 8 of datasheet. If your battery is not listed on the table, please contact ON Semiconductor.

Q. Why does the Fuel Gauge continue to display the same voltage or temperature or RSOC?

A. Please ensure that Fuel gauge is not in Sleep mode. Please set Operational mode if so.

Q. Can I load the other battery profile to the Fuel Gauge?

A. Yes. You can load a new battery profile to the Fuel Gauge using Evaluation board or Master device via I2C. Please contact ON Semiconductor for details.



7 Related Documents

Please obtain the latest documents about LC709204F at ON Semiconductor Web site (www.onsemi.com). Search part number: LC709204F.

- 1) LC709204F, *Smart LiB Gauge Battery Fuel Gauge LSI for 1-Cell Lithium-ion/Polymer (Li+) Data Sheet*
- 2) LC709204F, *Application Note*
- 3) LC709204F, *Evaluation Board Documents*
- 4) LC709204F, *Software FGICTool*

8 Revision history

Version	Date	Details
1.0	01/09/2019	Initial release